

OPERATING GUIDE for your GEM-RP4C and GEM-RP4RFC KEYPAD

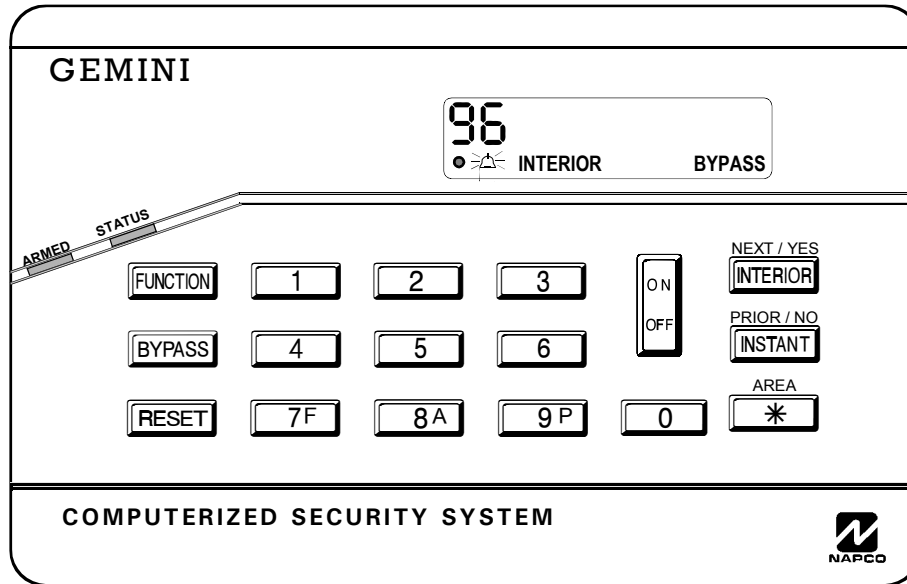

INTRODUCTION

The GEM-RP4RFC and the GEM-RP4C are “*smart*”, interactive, menu-driven keypads designed for your Napco control panel. A digital display is provided with each keypad to show the status of your system.

This booklet contains important information about the operation of your system with your keypad. Read it carefully and keep it handy for future reference. Check the Glossary for an

explanation of terms that may be unfamiliar to you.

You will probably find subjects mentioned in this booklet that do not apply to your system. Napco control panels have such a wide variety of features that few security systems, if any, will ever need them all. Your alarm professional has chosen appropriate features for your particular needs.

Regardless of how your system has been configured, rest assured that it has been carefully designed and engineered to the highest industry standards. To assure optimum safety and security, familiarize yourself with this equipment. Periodically check its condition and state of readiness by testing it at least once a week in both the AC/battery and battery-only modes (ask your alarm professional how to make these tests).

IMPORTANT - TEST YOUR SYSTEM WEEKLY

Test your sounding device and backup battery

1. While disarmed, press **FUNCTION**.
2. Answer NO (press **INSTANT**) until “3” (Bell Test) appears in the window.
3. Press YES (**INTERIOR**) to execute the test. The alarm will sound for about two seconds.
 - If the alarm does not sound, call for service.
 - If the battery is low, a system trouble E02 will appear in the display. Allow 24 hours for the battery to recharge. If the trouble continues, call for service.

Test your central station communicator

1. While disarmed, press **FUNCTION**.
2. Answer NO (press **INSTANT**) until “15” (Telephone Test) appears in the window.
3. Press YES (**INTERIOR**) to send a test code to the central station.
4. If the test is not successful, “E03” will display, indicating a communication failure. Call for service.

TABLE OF CONTENTS

TABLE OF CONTENTS

Section	Page
KEYPAD CONTROLS & INDICATORS	4
SETTING THE ALARM (ARMING) WHEN LEAVING	6
PROTECTING YOURSELF WHILE ON THE PREMISES	8
TURNING OFF THE ALARM (DISARMING) WHEN RETURNING.....	10
FIRE PROTECTION.....	11
KEYPAD FUNCTIONS	15
CENTRAL-STATION MONITORING	20
ADVANCED FEATURES	21
PROGRAMMING USER CODES	22
GLOSSARY	24
SYSTEM TROUBLE ERROR CODES	27
TROUBLESHOOTING	31

TO SILENCE AN ALARM, ENTER YOUR
CODE, AND PRESS .

FOR SERVICE, CALL: _____

CENTRAL STATION: _____

EXIT DELAY: _____

ENTRY DELAY: _____

FIRE ALARM SOUND*:

BURGLAR ALARM SOUND*:

KEYPAD FIRE ENABLED? YES NO

KEYPAD PANIC ENABLED? YES NO







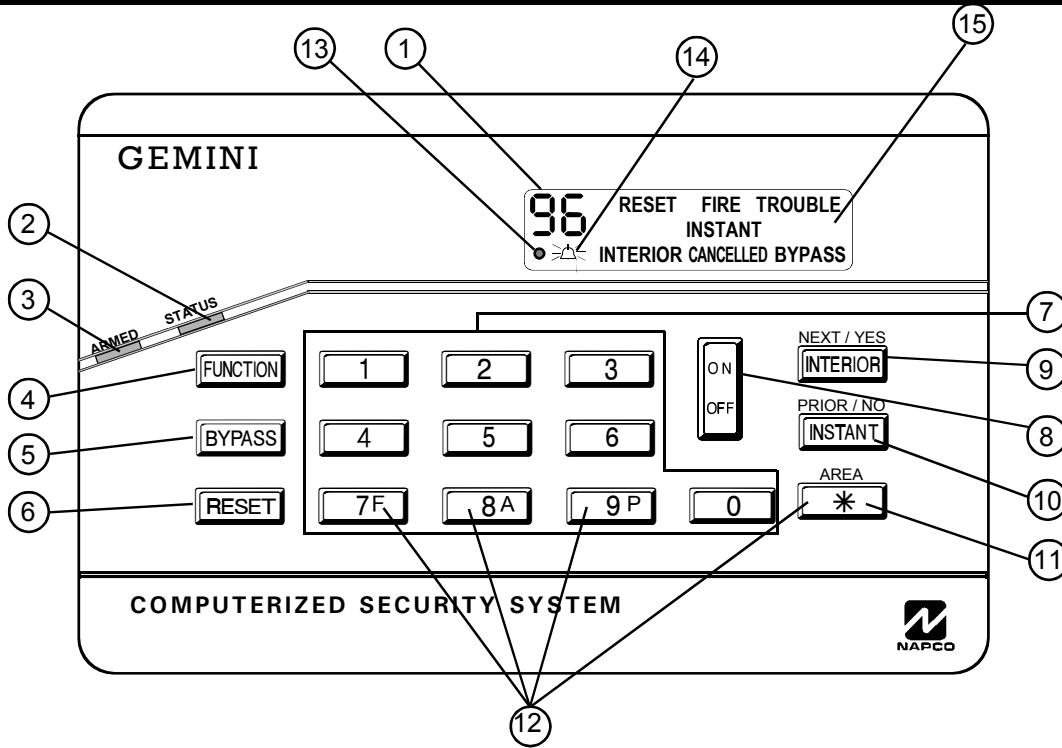



KEYPAD AUX. ENABLED? YES NO

*FIRE HAS PRIORITY OVER BURGLARY.

KEYPAD CONTROLS & INDICATORS



KEYPAD CONTROLS & INDICATORS

- ① **Window.** LCD readout indicates system status messages; digit display indicates related zone, function or error message numbers.
- ② **STATUS Light.** Lights (green) to indicate that the system is ready for arming. If a zone is not secured, the light will be off and the zone will display in the window. If a zone has been bypassed, the STATUS light will blink while armed.
- ③ **ARMED Light.** Lights (red) to indicate that the system is armed. If an alarm has occurred, the ARMED LED will be flashing.
- ④ **FUNCTION Button.** Selects available system functions as displayed in the window. The selected function is executed by pressing , or YES ().
- ⑤ **BYPASS Button.** (1) Deactivates selected zones from the system. (2) Unbypasses a bypassed zone (Optional).
- ⑥ **RESET Button.** (1) Resets various system troubles, displays, etc. (See text.) (2) Resets residential smoke detectors.
- ⑦ **Numerical Keys (1-9, 0).** Used to enter codes, zone numbers, etc.
- ⑧ **ON/OFF Button.** Entry key. Causes the entered code or selected function to be executed.
- ⑨ **INTERIOR Button.** (1) Bypasses all Interior Zones simultaneously to allow free movement within the premises. (2) Scrolls the window display forward (NEXT). (3) Answers "YES" to questions in the window display.
- ⑩ **INSTANT Button.** (1) Cancels entry delay on Exit/Entry Zones, causing an instant alarm upon violation. (2) Scrolls window display backward (PRIOR). (3) Answers "NO" to questions in the window display.
- ⑪ **AREA Button** (). Selects other areas.
- ⑫ **Emergency Buttons.** (Optional) Used with the  button to signal an emergency, as follows:
- Press the  and the  buttons for Fire Emergency.
 - Press the  and the  buttons for Auxiliary Emergency.
 - Press the  and the  buttons for Police Emergency.
- ⑬ **AC On Indicator.** Indicates AC Power is present.
- ⑭ **Chime.** Indicates door chime is turned on.
- ⑮ **System Status Messages.** Messages appear in display window when active. Includes RESET, FIRE, TROUBLE, INSTANT, INTERIOR, CANCELLED, and BYPASS.

SETTING THE ALARM (ARMING) WHEN LEAVING



Arming the System

- 1. Check the keypad.** The green STATUS light must be on in order to arm. If the green light is off, the number(s) of any unsecured zone(s) will display in the window. Refer to the pull-up zone list for the location of each problem zone and secure by closing windows, doors, etc.. When all zones are secure, the green STATUS light will come on.
- 2. Arm the system.** Enter your User Code followed by . The green STATUS light will go off, the red ARMED light will come on. **Note:** If you enter an invalid code, the keypad will beep 4 times, indicating an error. Re-enter your code.
- 3. Leave the premises.** Leave through the exit door before the exit time expires.



Priority Arming

If you attempt to arm the system with a faulted Zone, a 3-second tone will sound at the keypad and “P” will display in the window, indicating that the zones must be secured before the panel can be armed.

Selectively Bypassing Zones

If you cannot locate or repair a faulted zone, it can be removed from the system, *or bypassed*. Bypass the zone(s) from the system by pressing , followed by the zone number (or vice versa). The BYPASS icon in the display will turn on to indicate that the zone has been bypassed.

Note: Bypassed zones are unprotected. If a faulted zone cannot be secured, have the system checked as soon as possible.



SETTING THE ALARM (ARMING) WHEN LEAVING







System Trouble If you attempt to arm with the TROUBLE icon on, a 3-second tone will sound and a “P” will display in the window. This indicates that the system has detected a problem which may prevent it from operating properly. A number corresponding to the trouble will then appear in the display. Refer to SYSTEM TROUBLE ERROR CODES for descriptions of these troubles. If you cannot correct the problem immediately, press  and you will then be able to arm the system in this condition. **Note:** If you cannot clear the trouble, have the system checked as soon as possible.

Area Arming (Optional)



In a system that has been partitioned into multiple areas, one or more areas may be armed while others remain disarmed.



Manager's Mode.

The Manager's Mode allows the user to arm / disarm other areas in a partitioned system. *To arm a different area:*

1. Press the numerical key representing the other area number.
2. Press  followed by . The keypad will now provide status and control of that area.
3. Enter your code followed by  to arm.
4. Press  followed by  to return to the home area.

Global Arming (For GEM-P9600/3200 panels only).

To arm all areas simultaneously (including the area you are in), press ,  and enter your code followed by .



To disarm all areas simultaneously, press ,  and enter your code followed by .

- The User Code must be valid in all area(s).
- If any zone is not secured, the keypad will display “P”. All faulted zones in the respective area(s) must be secured or bypassed. **Note:** If a system trouble is indicated, the system cannot be armed using this method.







PROTECTING YOURSELF WHILE ON THE PREMISES



Bypassing Interior Zones

Interior Zones, when bypassed, allow free movement within the home while the protection of armed perimeter zones is maintained. To bypass Interior Zones, press  and enter your User Code followed by . The red ARMED light will light and

the green STATUS light will blink, indicating zones bypassed. The INTERIOR and BYPASS lights will display in the window. Your system may have provisions for two groups of Interior Zones. (Optional--Interior Groups programmed? YES NO)

- Press , followed by  to Bypass Interior Group 1: [_____]
- Press  twice followed by  to Bypass Interior Group 2: [_____]
- Press  three times followed by  to Bypass both Interior Groups 1 & 2. (Bypass Interior Group 2 available on GEM-P9600/3200)

Automatic Interior Bypass (Optional - Automatic Interior Bypass programmed? YES NO)

Your system may have been programmed for Automatic Interior Bypass, which allows it to recognize that you have armed the system and remained in the house, prompting it to automatically adjust the interior protection accordingly.

- If you arm the system and remain in the house, all Interior Zones are automatically bypassed. The INTERIOR and/or BYPASS icon in the window will remain lit, indicating that it is safe to move about the premises.
- If the system is armed and you leave, the Interior Zones will unbypass, providing complete interior protection.

Instant Protection

When retiring for the evening, after all family members are home, you can cancel the entry delay on the Entry Zone(s). To arm with instant protection, press  just prior to arming, or at any time after the system is armed. When armed with Instant Protection opening the entry door will cause an immediate alarm.

- When arming with Instant Protection, the exit delay will remain in effect, allowing exit of the house just after arming. While armed, the red ARMED light will flicker rapidly to indicate instant protection.

PROTECTING YOURSELF WHILE ON THE PREMISES

Easy Exit (Optional - Easy Exit programmed? YES NO)





Your system may have been programmed for Easy Exit, which allows a user to exit the premises while the system is armed. By activating Easy Exit while the system is armed, the Exit Delay countdown will take place, during which time you are permitted to leave through the exit door. The Easy Exit Delay time will be identical to the Exit Delay time the system gives you each time it is armed. This will allow, for example, an early morning commuter to exit the house, without having to disarm and rearm the system, awaking the family.

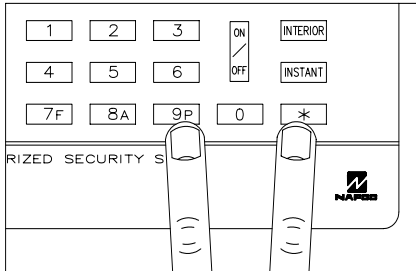





Press  to activate Easy Exit on your system. (GEM-P3200/GEM-P9600 V11D or less, GEM-P1632 V8G or less)

Press  to activate Easy Exit on your system. (GEM-P3200/GEM-P9600 V20 or greater, GEM-P816/P1632 V9A or greater)



Emergency Buttons (Only available if programmed)

The Blue Emergency Buttons (,  & ), if programmed, are always active, whether the system is armed or disarmed. The emergency signal will only be transmitted when an Emergency Button and  are pressed at the same time.

- **Fire Emergency** Simultaneously press  and  to alert the central station of a fire emergency. * (Fire Emergency programmed? YES NO)
- **Auxiliary Emergency** Simultaneously press  and  to alert the central station of an Auxiliary emergency. * (Auxiliary Emergency programmed? YES NO)
- **Police Emergency** Simultaneously press  and  to alert the central station of a police emergency. * (Police Emergency programmed? YES NO)

* **Note:** Discuss your Emergency Features with your Installation Company.

TURNING OFF THE ALARM (DISARMING) WHEN RETURNING



Disarming the System

1. Enter your premises through the Entry/Exit door. The keypad will sound a steady tone to remind you to disarm the system before your Entry Delay time expires.
 2. Enter your User Code and press . The red ARMED light will go out, indicating that the system has been disarmed.
- If you enter an invalid code, the keypad will beep 4 times, signifying an error. Re-enter your code immediately. 10 seconds before Entry Delay expires, the keypad will emit a pulsing warning tone.

Alarm Indication / Silencing an Alarm







If the red ARMED light is flashing upon entry, an alarm occurred while you were out. (The display will scroll the number(s) of the violated zone(s).) Proceed with caution! If you suspect that an intruder may still be on the premises, leave immediately and call authorities from a neighbor's phone.





To silence an audible alarm:

1. Enter your code and press . After the system is disarmed, the window will continue to display the number(s) of the zone(s) violated.
2. To reset the display, note the zones violated, then press .

Ambush (Optional) Your Ambush Code Type is: TYPE 1 (Prefix) TYPE 2 (Unique) **My Ambush Code is** _____

If an intruder forces you to disarm your system, enter your Ambush Code and press . There are two types of Ambush Codes: **(1)** A 2-digit code (prefix) entered just prior to your normal User Code and **(2)** A separate and unique User Code.

Example Type 1 (Prefix): If your User Code is 1234 and your Ambush Code is 99, press       .

Example Type 2 (Unique): If your User Code is 1234 and your Ambush Code is 8899, press     .

Using your Ambush Code will send a *silent alarm* to the central station. The red ARMED light will go out and the window will display "SYSTEM READY" as if the system were normally disarmed. There will be no indication that a silent alarm has been sent.

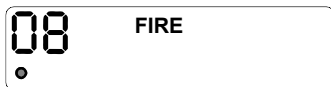

FIRE PROTECTION

(Applicable only where local ordinance permits use of this alarm control panel for fire protection).



Fire-Zone Alarm

If a fire is detected, the FIRE icon will flash with the zone number, and the keypad sounder will pulse.

- If a fire is in progress, evacuate the premises immediately! If necessary, call the Fire Department from an outside phone.
- If there is no evidence of a fire, enter your code and press  to silence the alarm.
- Check the smoke detector(s). If a smoke detector tripped, its red alarm indicator light will be on.
- After the alarm condition is corrected (thermostat cooled down; smoke cleared from detector; etc.), pressing  again will reset the keypad within about 10 seconds.



Fire-Zone Trouble

- The system is constantly monitoring the Fire Zone(s) to insure they are in good working order.
- If a problem on a Fire Zone is detected, a system trouble E41 will display, followed by the number of the Fire Zone in trouble. The sounder will activate, the RESET and TROUBLE icon will come on and the FIRE icon will blink.
- Press the  button to silence the sounder. Call for service immediately!

Note: *Trouble Error Code E41 will only display for the GEM-P1664/P1632 & P816 control panels.*

FIRE PROTECTION

Preparing a Fire Escape Plan

Even with the most advanced fire alarm system, adequate protection requires an escape plan.

To prepare your plan, draw floor plans of your building. (Space is provided on the next page). Show two exits - a front or back door and a window from each room. (Make sure the window works. You may need a special fire-escape ladder if the window is high up). Write down your outside meeting place.

Family Rehearsal.

Rehearse each of the following activities:

1. Everyone in his room with the doors closed.

2. One person sounds the alarm.
3. Each person tests his door.
4. Pretend the door is hot and use the alternate escape exit.
5. Everyone meets outdoors at the assigned location.

Important! - Read Carefully

Discuss these escape procedures with all those who use the building:

1. In a residence, sleep with the bedroom door closed. A closed door will hold back deadly smoke while you escape.
2. When the fire alarm signals, escape quickly. Do not stop to pack.
3. Test the door. If it is hot, use your

alternate route through the window. If the door is cool, brace your shoulder against it and open it cautiously. Be ready to slam the door if smoke or heat rushes in. Crawl through smoke, holding your breath. Close the doors again on leaving to help prevent the fire from spreading.

4. Go to your specific outdoor meeting place so you can see that everyone is safe.
5. Assign someone to make sure nobody returns to the burning building.
6. Call the Fire Department from a neighbor's telephone.

Would You Like More Safety Information?

For more information on home fire detection, burn safety, and home fire safety, write to the National Fire Protection Association, Public Affairs Dept. 05A, Batterymarch Plaza, Quincy, MA 02269.

FIRE PROTECTION

Floorplan

Draw a plan of your premises in the space provided below.

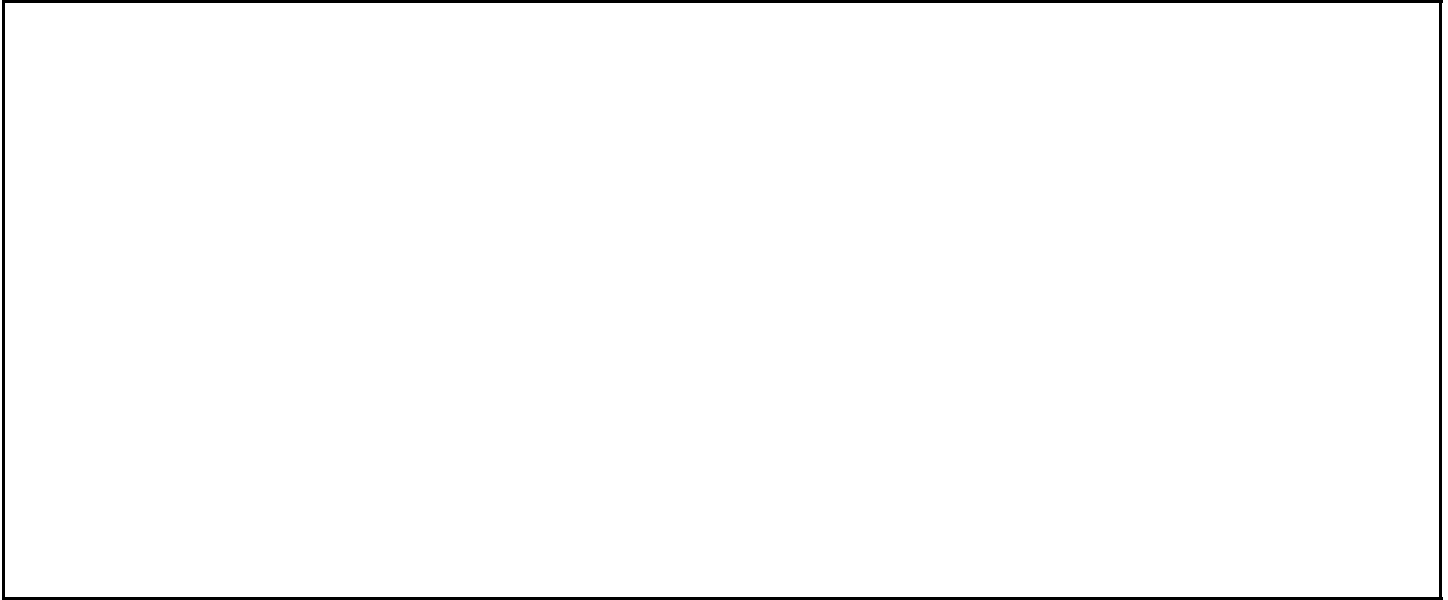
A large, empty rectangular box with a black border, intended for drawing a floorplan of the premises.

Floorplan

FIRE PROTECTION

LIMITATIONS OF FIRE ALARM WARNING SYSTEM

Although a fire alarm system may be of a reliable and state-of-the-art design, neither it nor its peripheral detection devices can offer guaranteed protection against fire. Any such equipment may fail to warn for a variety of reasons:

Control panels, communicators, dialers, smoke detectors, and many other sensing devices will not work without power. Battery-operated devices will not work without batteries, with dead batteries, or with improperly-installed batteries. Devices powered solely by AC will not work if their power source is cut off for any reason.

Fires often cause a failure of electrical power. If the system does not contain a working battery backup power supply, and if the electrical circuit feeding the devices is cut or is not providing power for any reason, the system will not detect heat or smoke or provide any warning of a possible fire.

Telephone lines needed to transmit alarm signals to a central monitoring station may be out of service.

Smoke detectors, though highly effective in reducing fire deaths, may not activate or

provide early-enough warning for a variety of reasons: (a) they may not sense fires that start where smoke cannot reach them, such as in chimneys, walls, roofs, behind closed doors, etc.; (b) they may not sense a fire on a different level of the residence or building; (c) they have sensing limitations; no smoke detector can sense every kind of fire every time.

Thermostatic heat detectors do not always detect fires because the fire may be a slow smoldering low-heat type (producing smoke); because they may not be near the fire; or because the heat of the fire may bypass them. These detectors will not detect oxygen levels, smoke, toxic gases, or flames. Therefore, they may only be used as part of a comprehensive fire-detection system in conjunction with other devices. Under no circumstances should thermostatic heat detectors be relied upon as the sole measure to ensure fire safety.

Alarm warning devices such as sirens, bells, or horns may not alert someone behind a closed or partially-opened door. Warning devices located on one level are less likely to alert those on a different level. Even those who are awake may not hear the warning if the

alarm is obscured by noise from a stereo, radio, air conditioner, or other appliance, or by passing traffic, etc. Alarm warning devices, however loud, may fail to warn the hearing impaired.

Alarm products, as all electrical devices, are subject to component failure. Even though the equipment is designed for many years of trouble-free performance, electronic components could fail at any time.

Above are some of the reasons that fire alarm equipment could fail. The most common cause of an alarm system not functioning when a fire occurs is inadequate testing and maintenance. The system should be tested at least weekly to ensure that all the equipment is working properly.

While an alarm system may make one eligible for lower insurance rates, it is not a substitute for insurance. Homeowners, property owners, and renters are therefore urged to maintain adequate insurance coverage of life and property.

KEYPAD FUNCTIONS

The keypad can provide access to a wide assortment of utility functions. The functions are displayed in a prompting “YES/NO” format.

1. To enter the Function Menu, press **FUNCTION**.
 - In all UL-listed or high-security installations, a valid User Code must first be entered followed by **FUNCTION**.
2. To skip a function, answer NO (**INSTANT**) or **FUNCTION**.
3. To select and execute a function, answer YES (**INTERIOR**) or **ON/OFF**.
 - Functions may be manually scrolled forward or backward using **FUNCTION** and **BYPASS**, respectively.
 - To return to normal keypad operation, press the **RESET** button. The keypad will automatically return to its normal operating mode if no activity is detected for longer than one minute.



1. **Display Zone Status?** Displays the zone number of zones that are not secured. Press the NEXT and PRIOR Buttons (as displayed on-screen) to scroll faulted zones (required for GEM-P3200/9600 panels. GEM-P816/1632 panels will *auto-scroll*).
2. **Display Zones Bypassed?** Displays bypassed zones. Press NEXT (**INTERIOR**) and PRIOR (**INSTANT**) to scroll bypassed zones (required for GEM-P3200/9600 panels. GEM-P816/1632 panels will *auto-scroll*).
3. **Activate Bell Test?** Activates the alarm (while disarmed) for about 2 seconds and performs a battery test. If the alarm does not sound, call for service. If the battery is low, a system trouble E02 will appear in the display. Allow 24 hours for the battery to recharge. If the trouble continues, call for service.

KEYPAD FUNCTIONS

04
•

4. Display System Troubles? Displays a 1- or 2-digit error code representing a problem detected in the system. (See SYSTEM TROUBLE ERROR CODES for a description of these codes). Use NEXT(**INTERIOR**) and PRIOR (**INSTANT**) to scroll system troubles. (For GEM-P9600/3200 panels only).

05
•

5. Display Fire Alarms? Displays alarms that have occurred on the Fire Zone(s). Press the NEXT and PRIOR Buttons to scroll zones (required for GEM-P3200/9600 panels. GEM-P816/1632 panels will *auto-scroll*).

06
•

6. Display Fire Troubles? Displays trouble conditions that have been detected on the Fire Zone(s). Use NEXT(**INTERIOR**) and PRIOR (**INSTANT**) to scroll zones (required for GEM-P3200/9600 panels. GEM-P816/1632 panels will *auto-scroll*).

07
•

7. Activate Chime? The Chime Mode will sound a tone at the keypad when the programmed zone is opened while disarmed. To deactivate the Chime Mode, execute Function 7 once again. Note: The Chime Mode is disabled while armed.

08
•

8. Activate Watch Mode? (Optional - Watch Mode programmed? YES NO)
This optional feature simultaneously turns on all zones designated as Day Zones, which will cause an indication at the keypad if a zone is opened while the system is disarmed. To deactivate the Watch Mode, arm, then disarm. All Day Zones will revert to regular Burglary Zones. **Note:** The Watch Mode is disabled while armed. (**Note:** This function available with GEM-P9600 and GEM-P3200 control panels only).

KEYPAD FUNCTIONS



09

9. Reset System Trouble? System troubles display and sound at the keypad. Correcting the trouble will clear most indications, however the following error codes will require manual reset: E11; E13; E19; E20 and E22. (See SYSTEM TROUBLE ERROR CODES for a description of error codes).



10

10. Reset Sensor Watch Failure (Sensor Watch programmed? YES NO).

Your system may have been programmed for Sensor Watch, a feature which supervises the motion sensors in the system. If a Sensor Watch failure occurs, a System Trouble E22-NN will result, where NN represents the zone number of the sensor in question. To reset, press **RESET** to clear the display, enter the Function Menu, scroll to Reset Sensor Watch Failure and press . If you cannot correct the problem, call for service.

(Note: This function available with GEM-P9600 and GEM-P3200 control panels only. With the GEM-P816/1632 panels, "Sensor Watch Fail" is reset by "Reset System Trouble" function).



11

11. Start Exit Time? (Optional) (Start Exit Time programmed? YES NO)

In Commercial Burglary systems, exit delay may have been programmed to start after a central-station "ringback" (verification) signal has been received. If the ringback tone has not been received within about 30 seconds after arming, a communication problem may exist. Use this function to start exit delay manually, then exit the premises immediately. Be sure to have your alarm specialist check communications with the central station as soon as possible.

(Note: This function available with GEM-P9600 and GEM-P3200 control panels only).

KEYPAD FUNCTIONS

15
•

15. Activate Telephone Test? (Telephone Test programmed? YES NO). Sends a communicator test to the central station. A communication failure will be indicated at the keypad by a system trouble “E03-00” display. Repeat the test to attempt to correct a communication failure, as any successful communication will clear this display.

16
•

16. Delay Arming 1-4 hours. (Not for UL-listed systems). Your system may be set to arm automatically after a delay period of 1 to 4 hours.

To Delay Arm the system:

- With Function 16 in the window, enter the desired Delay Arming time in hours (, , , or) , followed by .

At the end of this 1 - 4 hour Delay Arming period, the siren will sound a 2-second warning and the keypad will begin a 15-minute arming countdown with the sounder pulsing. The sounder may be silenced at this time by pressing , but it will turn back on with a steady warning tone 1 minute prior to arming, at which time the building must be exited.

The same steps can be used to delay a scheduled Auto Arming, if your system has been programmed as such.

KEYPAD FUNCTIONS

17
•

18
•

19
•

17. Activate Program? Activates the Program Mode from Keypad No. 1. **Note:** This feature is disabled while armed. (See PROGRAMMING USER CODES).

18. Activate Download? For installer's use only. If accidentally enabled, press **RESET** to exit. **Note:** This feature is disabled while armed.

19. Relay Control? (Relay Control programmed? YES NO). Turns ON or OFF one or more programmed Relay Group. Press  to turn the displayed group on or off; press NEXT (**INTERIOR**) to proceed to the next group, or PRIOR (**INSTANT**) to scroll back to the previous group. Press **RESET** when done.

- Relay Group 01: [_____]
- Relay Group 02: [_____]
- Relay Group 03: [_____]
- Relay Group 04: [_____]
- Relay Group 05: [_____]
- Relay Group 06: [_____]
- Relay Group 07: [_____]
- Relay Group 08: [_____]

CENTRAL STATION MONITORING

Your alarm specialist may have programmed your system to be monitored by a central station. The built-in digital communicator can transmit emergency signals and status reports to the central station 24 hours a day.

Communicator Features

Abort Delay. Ask your installer which of your zones have Abort Delay, a delay that enables you to reset the system before it communicates to the central station. Your system has a SIA CP-01 required Abort Delay of 30 seconds. It may be removed or increased up to 45 seconds (at your option) by consulting with your installer.

Regular Burglary (Non-24-Hour) Zone reports are aborted by disarming within the delay period.

24-Hour Zones and zones programmed to report restores must be restored first, then the panel armed and disarmed, all within the delay period.

Opening and/or Closing Reporting. Your system can notify the central station every time it is disarmed or armed. Any or all of up to 96 different users can each be identified. If your system reports on arming (Closing

Report), the central station will acknowledge arming. This will signal at the keypad as a "ringback" beep. **Note:** If the ringback signal is not heard, call for service.

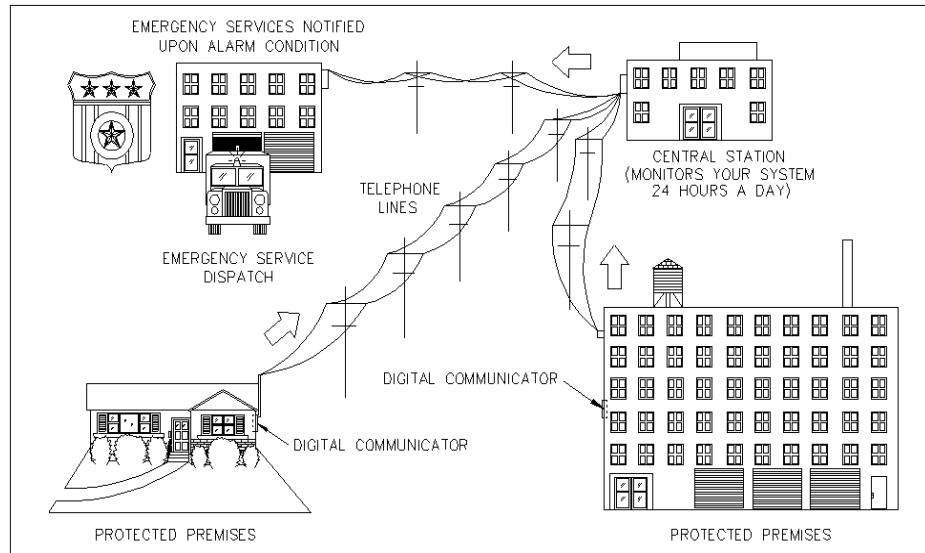

ADVANCED FEATURES

Security Bypass/Unbypass

(Security Bypass programmed? YES NO).

In high-security applications, zones may be bypassed (or unbypassed) only if a valid code is entered first, as follows:

1. Enter a User Code valid for bypass, then press **[BYPASS]**.
2. Press **[BYPASS]** then the zone number (or vice versa) to deactivate that zone.

Similarly, a bypassed zone may be unbypassed using the same procedure. (This feature available for GEM-P3200/9600 panels only).

Start Exit Time After Ringback (for Commercial Burglary Systems only)

(Optional - Start Exit Time programmed? YES NO).

If your system reports to a central station, your panel may have been programmed to start exit delay after the central-station ringback (verification) signal. Then, after arming, your system will communicate to the central station. After the central station acknowledges receipt (ringback), exit delay will start. If ringback is not heard within about 30 seconds, a communication problem may exist; call for service. Function 11 (Start Exit Time) may then be used to manually start the exit delay, however reporting capability may be sacrificed. (If your system does not report or the ringback feature was not programmed, exit delay will start as soon as your code is entered. Also note that if an exception window is programmed, and the closing is within that window, no ringback is provided. Ask your alarm professional if this feature is enabled). (This feature available for GEM-P3200/9600 panels only).

Exit-Delay Restart

(Exit-Delay Restart programmed? YES NO).

On arming, the programmed exit delay will start. After the exit/entry door has been opened and then closed, exit delay will restart if the door is opened again. The Exit-Delay Restart feature will occur one time only in any arming period. (This feature available for GEM-P3200/9600 panels only).

PROGRAMMING USER CODES

Your Installer has programmed into your system a special User Program Code which can be used to not only Arm and Disarm the system, but also to enter the User Program Mode, where you can program other User Codes. The following explains how you will use this code to program or erase additional User Codes.

Entering the User Program Mode

- 1 Enter your User Code, then press **FUNCTION** to enter the Function Mode.
- 2 Answer NO (press **INSTANT**) until "17" (Activate Program) is displayed, then press YES (**INTERIOR**).
The display will scroll the following: "P" (Program mode); 4 digits identifying software versions; then "UP" (User Program).
The keypad sounder will beep while in the User Program Mode.

Programming / Reprogramming a User Code

- 1 Press **FUNCTION**, followed by the the 2 digits of the user number to be programmed (Example: for User 4, enter 04).
- 2 Press **FUNCTION**, followed by the new User Code (up to 6 digits).
- 3 Press **FUNCTION** repeatedly until "UP" is displayed.
- 4 Press **ON/OFF** to save the new User Code. **Note:** Duplicate Codes are not allowed; therefore a duplicate Code entered in the LCD Window will erase when **ON/OFF** is pressed. Repeat Steps 1 through 4 for each User Code to be programmed.

Erasing a User Code

To erase a User Code, press **FUNCTION**, the 2-digit user number, **FUNCTION** followed by ***** **0** until "UP" is displayed, then **ON/OFF**.

- Example: Erase User 3's User Code:

Press **FUNCTION** **0** **3** **FUNCTION** ***** **0** ***** **0** ***** **0** ***** **0** ***** **0** ***** **0** ("UP" will display) **ON/OFF**.

Reviewing a Programmed User Code

To review a User Code, press **FUNCTION**, the 2-digit user number and **FUNCTION** to step through and review each digit of code.

PROGRAMMING USER CODES

Exiting the User Program Mode

When you have completed programming or erasing User Codes, press **RESET** to exit the User Program Mode.

Programming Example:

Example. Program the User 3 Code to “3784”.

1. Enter your User Code, followed by **FUNCTION**.
2. Answer NO (press **INSTANT**) repeatedly until “17” is displayed, then press YES (**INTERIOR**).

The display will scroll “P” followed by 4 digits, then “UP” (indicating User Programming) and the keypad lights will flash.

3. Press **FUNCTION** followed by **0** **3** (for User 3), then **FUNCTION** again followed by **3** **7F** **8A** **4** **FUNCTION** **FUNCTION** to program the code. (“UP” will display)
4. Press **ON** **OFF** to save the code.
5. Press **RESET** to exit the Program Mode.

Notes:

- If the system contains more than one keypad, only the keypad designated “No. 1” may be used for programming (if in doubt which is No. 1, ask your installer).
- While in Program Mode, the ARMED and STATUS lights remain off and burglar and fire alarm functions are disabled. In selecting your codes, do not program repetitive numbers (1111), consecutive numbers (1234), your birth date, address, or other obvious combinations. Choose a code of up to six digits (a minimum of four is recommended, and required in UL installations). **Note:** Duplicate Codes are not allowed; therefore a duplicate Code entered in the LCD Window will erase when **ON** **OFF** is pressed.
- While in Program Mode, the keypad beeps every 15 seconds.
- If the keypad detects no Program Mode activity for more than 4 minutes, a steady tone will sound. Press **RESET** to silence.

GLOSSARY

Following are brief descriptions of terms and features used herein that may be unfamiliar to you. Some of the features are programmable options that may or may not apply to your particular system.

Abort Delay - A delay period that allows the control panel to be reset, thus aborting a report to a central station.

Access Code - A code (up to 6 digits) used to remotely unlock a door.

Ambush Code - Either (1) a 2-digit prefix code entered just prior to the User Code or (2) a unique 3-6-digit code used in place of the User Code when forced to disarm. Sends a silent alarm to the central station with no indication at the keypad.

Area - Some systems may be divided, or partitioned, into smaller independent subsystems, which are referred to as Areas. Each Area may be controlled by its own keypad or by a keypad of a different Area through Managers Mode.

Arming/Disarming - Turning the system on/off by entering your code at the keypad, then pressing .

Battery - Backup power source in the control-panel enclosure to provide protection in the event of a power failure.

BYPASS Button - Enables you to manually remove one or more protective zones from the system.

Central Station - Monitors incoming reports and emergency messages from a digital communicator and notifies the proper authorities.

Chime - A keypad beep while disarmed alerting that the programmed zone has been opened.

Closing Window - (Optional.) A

time interval within which closing (arming) is permitted without reporting to the central station.

Communicator - Reports intrusions, emergencies, openings, closings, etc. directly to the central station over telephone lines.

Control Panel - The brain of the system, it controls all system functions.

Easy Arming - Quick arming by pressing  (optional).

Exit/Entry Delays - Separate delays that let you exit and enter your premises without setting off an alarm when the system is armed.









GLOSSARY

Instant Protection - Arming without entry delay using the  button while remaining on the premises.

INTERIOR Button - Bypasses Interior Zones on arming (see Zones - Interior Zones).

Keypad - Puts control-panel functions at your fingertips. It can be mounted anywhere in your premises.

Manager's Mode - In a partitioned system, a low-security operating mode that allows arming by area.

Panic Buttons - Blue buttons on the keypad ( and ,  or ). If enabled, pressing  together with ,  or  will alert the central station of a fire, auxiliary, or police emergency.

Partitioned System - A system that has been subdivided into two or

more (up to eight) independent subsystems (areas).

Pre-Alarm Warning. - A keypad sounder alert of an impending alarm. This option is programmable by zone for the same duration as that programmed for Abort Delay (see Abort Delay).

Report - A transmission to a central station notifying of a change in the status of the system (alarm, trouble, low battery, etc.).

RF Low Battery - (Wireless systems only) Weak transmitter battery.

RF Supervisory - (Wireless systems only) Periodic test report from transmitter (if a report is not received on time, a supervisory-failure system trouble will result).

Ringback - A beep after arming verifying the central-station's receipt of a closing report.

Service Code - A code intended for temporary use.

Sounder - A local warning device at each keypad to alert that (a) entry delay has started; (b) an attempt was made to arm with a zone in trouble; (c) a Day-Zone condition exists (see Zones: Day Zone); (d) 10 seconds exit time remaining; (e) invalid code entered; or (f) central station acknowledged arming (see Ringback).

System Trouble - A problem (low battery, power failure, etc.) detected in the system.

Trouble - A zone fault; an open door, window, or other problem that may prevent arming.

User Code - Your personalized code for arming and disarming the system. It may contain up to six digits.

GLOSSARY

Zones - Independent circuits that protect specific areas of the premises:

- *Auto-Bypass Zone*: A zone that will be automatically bypassed from the protection system if it is in trouble (faulty) when the system is armed.
- *Burglary Zone*: Detects intrusion.
- *Day Zone*: A zone that will cause a visual and audible indication at the keypad if it is in trouble while disarmed.
- *Exit/Entry Follower Zone*: Provides exit and entry delay for interior devices. Entry delay only occurs if re-entry takes place through the normal exit/entry door first.
- *Fire Zone*: Detects fire alarms or trouble conditions.
- *Interior Zones*: Circuits within the premises, usually including space-protection devices, interior doors, etc.; but not exterior doors or windows. These can all be bypassed simultaneously by pressing **INTERIOR**. (Two groups of Interior Zones may be programmed for each area).
- *Priority Zone*: A zone that prevents arming if in trouble.
- *Priority Zone with Bypass*: A Priority Zone that can be bypassed using the **RESET** button.
- *Selective-Bypassed Zone*: A zone that can be individually bypassed pressing **BYPASS**, followed by the zone number.
- *24-Hour Zone*: A zone that is armed and ready at all times to respond to an emergency situation.

SYSTEM TROUBLE ERROR CODES

Your control panel is capable of detecting a variety of troubles that may affect system performance. In the unlikely event that a problem should occur, the SYS TBL (system trouble) light will display in the keypad window along with one or more of the following error codes. If the problem is related to a specific zone or device, the corresponding number will also be indicated. Below is a list of the most common troubles along with the necessary corrective action, if any. If a message appears that is not listed below, call your security professional for service. When a system trouble occurs, the keypad can be silenced and the display can be cleared by pressing **[RESET]**. The system can then be armed and disarmed as usual.

Note: If you cannot clear a system trouble yourself, call installing company for service as soon as possible.

Trouble Indication	System Trouble Condition	Action
E-01	AC Power Failure	This trouble will occur if AC power is not present. Make sure system transformer is plugged into AC receptacle and check the circuit breaker, otherwise call installing company for service.
E-02	Low Battery	If there has been a recent power failure, the battery may be partially depleted and must be recharged by the control panel. The control panel performs an automatic test of the battery every 24 hours, at which time the trouble will clear if the battery has been recharged.
E-03	Communication Failure	The system was not able to report to central station. If this is due to a temporary interruption in the telephone service, the trouble can be cleared when the service is restored by performing a Communication Test: <ol style="list-style-type: none"> 1. While disarmed, enter your User Code followed by [MENU]. 2. Answer NO (press [AWAY]) until "15" (Telephone Test) appears in the window. 3. Press YES ([STAY]) to send a test signal to the central station.

SYSTEM TROUBLE ERROR CODES

Trouble Indication	System Trouble Condition	Action
E-04-NN	Wireless Transmitter Supervisory Failure	A problem has been detected with a wireless transmitter. Call installing company for service.
E-05-NN	Wireless Transmitter Low Battery	<p>The battery in a wireless transmitter is low and should be replaced. This transmitter is on the zone corresponding to the number NN. The replacement battery for the GEM-TRANS2 door/window transmitter, GEM-PIR motion detector and GEM-GB glass break detector is the Duracell DL123A 3 volt lithium. (2 required for the GEM-PIR and GEM-GB). The replacement battery for the GEM-SMK is the Duracell MN1604 9 Volt Alkaline(2 required). The GEM-DT Dual Technology Sensor requires 4 C cell alkaline batteries.</p> <p><i>Warning: Replace batteries only with the same type as specified above. Use of another battery may present a risk of fire or explosion. Do not recharge or disassemble battery, or dispose of in fire.</i></p>
E-06-NN	Receiver Response Failure	Call installing company for service.
E-07-00	Download Failure	Call installing company for service.
E-08	Telephone Line Cut	The telephone line has failed. If telephone service has been temporarily interrupted, the trouble will clear automatically when it is restored. Otherwise, call installing company for service.
E-09-00	System Cold Start	
E-10-NN	Keypad Response Failure	Call installing company for service.

SYSTEM TROUBLE ERROR CODES

Trouble Indication	System Trouble Condition	Action
E-11-NN	Keypad Tamper	A keypad has been removed for the wall. Call installing company for service if problem cannot be repaired.
E-12-NN	Expansion Zone Module Response Failure	Call installing company for service.
E-13-NN	Expansion Module Tamper	The cover has been removed from a zone expansion module. A problem has been detected with an Expansion Module. Call installing company for service.
E-14-NN	Relay Board Response Failure	NN= Relay Board Number. Call installing company for service.
E-15-NN	RF Transmitter Tamper	Wireless Transmitter Tamper Cover removed. NN=Transmitter Number. Call installing company for service.
E-16-NN	Wireless Receiver Jam	A problem has been detected with the wireless receiver. Call installing company for service.
E-17-NN	Receiver Tamper Condition	Call installing company for service.
E-18-NN	KeyFob Transmitter Low Battery	<p>The batteries (2) in the wireless KeyFob transmitter indicated are low and should be replaced. The replacement battery is the #386 watch battery.</p> <p><i>Warning: Replace batteries only with the same type as specified above. Use of another battery may present a risk of fire or explosion. Do not recharge or disassemble battery, or dispose of in fire.</i></p>

SYSTEM TROUBLE ERROR CODES

Trouble Indication	System Trouble Condition	Action
E19-00	User Program Memory Error	Call installing company for service.
E-20-00	Dealer Program Memory Error	Call installing company for service.
E-21-00	System Shutdown	Call installing company for service.
E-22-NN	Sensor Watch Activity Failure	A Motion Sensor on the zone indicated has failed the programmed Sensor Watch activity test. Insure that the sensor is able to detect activity in the area; clear any obstacles which may be blocking the sensor from detecting activity. Press RESET to clear the display, and then use the Function Menu to Reset Sensor Watch Failure (see page 17). If you cannot correct the problem yourself, call installing company for service.
E-23-00	Burglary Bus Failure	Call installing company for service.
E-24	Service Message	The system is in need of a preventive maintenance service call.
E-27-00	Printer Failure	Call installing company for service.
E-39-00	Receiver Capacity Error	Call installing company for service.
E-40-NN	RF Self Test Failure	A wireless motion sensor on the zone indicated has failed its automatic self test routine. Call installing company for service.
E-41-NN	Fire Trouble	A problem has been detected on the Fire zone indicated. Call for service. (GEM-P1632 and GEM-P816 panels only).
E-51	Bell/Siren Trouble	There is a problem with the Bell or Siren. Call installing company for service.
E-58-00	Telemetry Trouble	Call installing company for service.
E-59-00	Telemetry Failure	Call installing company for service.
E-66-00	"Clean Me" Smoke Detector Dirty	Clean detector or call installing company for service.
E-99-00	Keypad Panic Shorted too Long	Call installing company for service.

TROUBLESHOOTING

What do I do if...

For more info...

I try to arm my system but the keypad just displays a P and beeps at me.

If the green STATUS light is off, a zone is open. Refer to the Pull Up Zone Directory and find and secure the open window or door.

See Page 6

I try to arm my system but the keypad displays a P and beeps at me. The TROUBLE icon is lit and numbers start scrolling in the display.

*A System Trouble has been detected. Note the scrolling error codes, which represent the trouble. Press **RESET** and you will now be able arm to the system , but the trouble must be fixed as soon as possible.*

See Page 7 & 27

The Fire Alarm is sounding and I don't know how to turn it off.

*If a fire is in progress, evacuate the premises immediately! If necessary, call the Fire Department from an outside telephone. If there is no evidence of a fire, enter your code and press  to silence the alarm. Note the number of the Zone flashing in the window. Check the smoke detector(s). If a smoke detector tripped, its red alarm indicator light will be on. Press **RESET** to silence the keypad sounder.*

See Page 11

NAPCO LIMITED WARRANTY

NAPCO SECURITY SYSTEMS, INC. (NAPCO) warrants its products to be free from manufacturing defects in materials and workmanship for thirty-six months following the date of manufacture. NAPCO will, within said period, at its option, repair or replace any product failing to operate correctly without charge to the original purchaser or user.

This warranty shall not apply to any equipment, or any part thereof, which has been repaired by others, improperly installed, improperly used, abused, altered, damaged, subjected to acts of God, or on which any serial numbers have been altered, defaced or removed. Seller will not be responsible for any dismantling or reinstallation charges.

THERE ARE NO WARRANTIES, EXPRESS OR IMPLIED, WHICH EXTEND BEYOND THE DESCRIPTION ON THE FACE HEREOF. THERE IS NO EXPRESS OR IMPLIED WARRANTY OF MERCHANTABILITY OR A WARRANTY OF FITNESS FOR A PARTICULAR PURPOSE. ADDITIONALLY, THIS WARRANTY IS IN LIEU OF ALL OTHER OBLIGATIONS OR LIABILITIES ON THE PART OF NAPCO.

Any action for breach of warranty, including but not limited to any implied warranty of merchantability, must be brought within the six months following the end of the warranty period.

IN NO CASE SHALL NAPCO BE LIABLE TO ANYONE FOR ANY CONSEQUENTIAL OR INCIDENTAL DAMAGES FOR BREACH OF THIS OR ANY OTHER WARRANTY, EXPRESS OR IMPLIED, EVEN IF THE LOSS OR DAMAGE IS CAUSED BY THE SELLER'S OWN NEGLIGENCE OR FAULT.

In case of defect, contact the security professional who installed and maintains your security system. In order to exercise the warranty, the product must be returned by the security professional, shipping costs prepaid and insured to NAPCO. After repair or replacement, NAPCO assumes the cost of returning products under warranty. NAPCO shall have no obligation under this warranty, or otherwise, if the product has been repaired by others, improperly installed, improperly used, abused, altered, damaged, subjected to accident, nuisance, flood, fire or acts of God, or on which any serial numbers have been altered, defaced or removed. NAPCO will not be responsible for any dismantling, reassembly or reinstallation charges.

This warranty contains the entire warranty. It is the sole warranty and any prior agreements or representations, whether oral or written, are either merged herein or are expressly cancelled.

THE FOLLOWING STATEMENT IS REQUIRED BY THE FCC.

This equipment generates and uses radio-frequency energy and, if not installed and used properly, that is, in strict accordance with the manufacturer's instructions, may cause interference to radio and television

reception. It has been type tested and found to comply with the limits for a Class-B computing device in accordance with the specifications in Subpart J of Part 15 of FCC Rules, which are designed to provide reasonable protection against such interference in a residential installation.

However, there is no guarantee that interference will not occur in a particular installation. If this equipment does cause interference to radio or television reception, which can be determined by

NAPCO neither assumes, nor authorizes any other person purporting to act on its behalf to modify, to change, or to assume for it, any other warranty or liability concerning its products.

In no event shall NAPCO be liable for an amount in excess of NAPCO's original selling price of the product, for any loss or damage, whether direct, indirect, incidental, consequential, or otherwise arising out of any failure of the product. Seller's warranty, as hereinabove set forth, shall not be enlarged, diminished or affected by and no obligation or liability shall arise or grow out of Seller's rendering of technical advice or service in connection with Buyer's order of the goods furnished hereunder.

NAPCO RECOMMENDS THAT THE ENTIRE SYSTEM BE COMPLETELY TESTED WEEKLY.

Warning: Despite frequent testing, and due to, but not limited to, any or all of the following: criminal tampering, electrical or communications disruption, it is possible for the system to fail to perform as expected. NAPCO does not represent that the product/system may not be compromised or circumvented; or that the product or system will prevent any personal injury or property loss by burglary, robbery, fire or otherwise; nor that the product or system will in all cases provide adequate warning or protection. A properly installed and maintained alarm may only reduce risk of burglary, robbery, fire or otherwise but it is not insurance or a guarantee that these events will not occur. CONSEQUENTLY, SELLER SHALL HAVE NO LIABILITY FOR ANY PERSONAL INJURY, PROPERTY DAMAGE, OR OTHER LOSS BASED ON A CLAIM THE PRODUCT FAILED TO GIVE WARNING. Therefore, the installer should in turn advise the consumer to take any and all precautions for his or her safety including, but not limited to, fleeing the premises and calling police or fire department, in order to mitigate the possibilities of harm and/or damage.

NAPCO is not an insurer of either the property or safety of the user's family or employees, and limits its liability for any loss or damage including incidental or consequential damages to NAPCO's original selling price of the product regardless of the cause of such loss or damage.

Some states do not allow limitations on how long an implied warranty lasts or do not allow the exclusion or limitation of incidental or consequential damages, or differentiate in their treatment of limitations of liability for ordinary or gross negligence, so the above limitations or exclusions may not apply to you. This Warranty gives you specific legal rights and you may also have other rights which vary from state to state.

turning the equipment off and on, the user is encouraged to try to correct the interference by one or more of the following measures: reorient the receiving antenna; relocate the computer with respect to the receiver; move the computer away from the receiver; plug the computer into a different outlet so that computer and receiver are on different branch circuits.

If necessary, the user should consult the dealer or an experienced radio/television technician for additional suggestions. The user may find the following booklet prepared by the Federal Communications Commission helpful: "How to Identify and Resolve Radio-TV Interference Problems". This booklet is available from the U.S. Government Printing Office, Washington, DC 20402; Stock No. 004-000-00345-4.